

MODEL - TRW216
 CAPACITY - 2000LBS
 WEIGHT - 424LBS
 T & P - 8050LBS

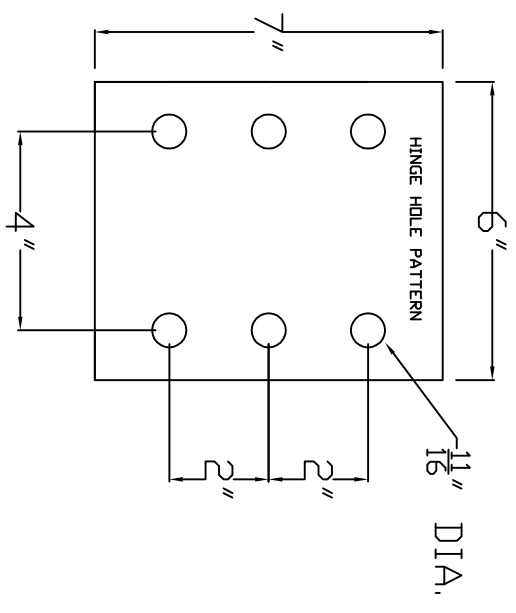

ADEQUACY OF MOUNTING SURFACE DETERMINED BY OTHERS. MOUNTING BOLTS NOT INCLUDED. USE GRADE 5 OR BETTER BOLTS. WEIGHTS ARE ESTIMATED.

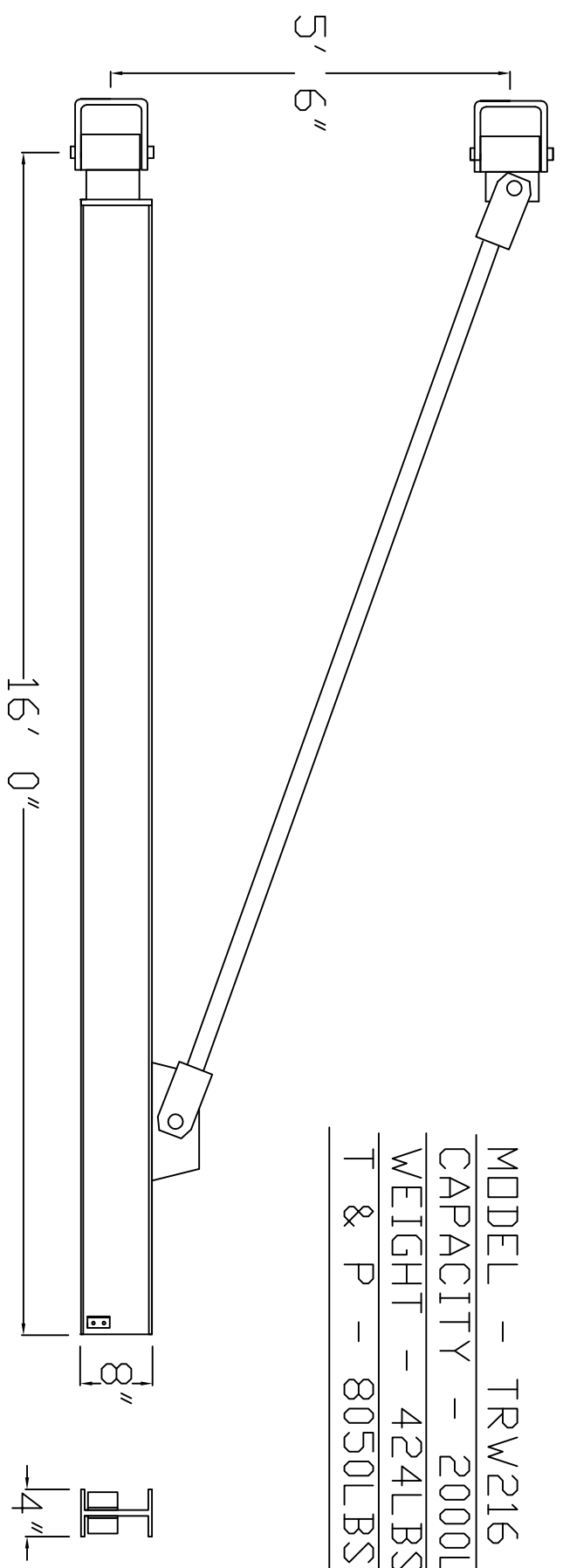

2127 W. NORDALE DR. APPLETON, WI 54914
 PH - 920-380-0397 FAX - 920-380-0845